

# *F811 - Redundant fieldbus power system for I/A Series® control systems*



**Instruction Manual**

**INM F811**



I/A Series® is a registered trademark of Invensys plc, London, England

# CONTENTS

PAGE

<b>1</b>	<b>OVERVIEW</b> .....	<b>1</b>
<b>2</b>	<b>COMPONENTS AND ACCESSORIES</b> .....	<b>1</b>
<b>3</b>	<b>DESCRIPTION</b> .....	<b>1</b>
<b>4</b>	<b>MECHANICAL INSTALLATION</b> .....	<b>2</b>
	4.1 General .....	2
	4.2 Mounting orientation .....	2
	4.3 Carrier mounting .....	3
	4.4 Mounting and removal of Modules .....	3
<b>5</b>	<b>ELECTRICAL INSTALLATION</b> .....	<b>3</b>
	5.1 Introduction .....	3
	5.2 Input power connections .....	3
	5.3 Alarm circuit .....	4
	5.4 Connections to I/A baseplate .....	4
	5.5 Fieldbus segment connections .....	4
	5.6 Grounding .....	4
	5.7 Diagnostics module .....	5
<b>6</b>	<b>TESTING &amp; TROUBLESHOOTING</b> .....	<b>5</b>
	6.1 F80x Status and Alarm LEDs .....	6
	6.2 Testing after installation .....	6
	6.3 Troubleshooting .....	6
<b>7</b>	<b>MAINTENANCE</b> .....	<b>6</b>
	7.1 Routine maintenance .....	6



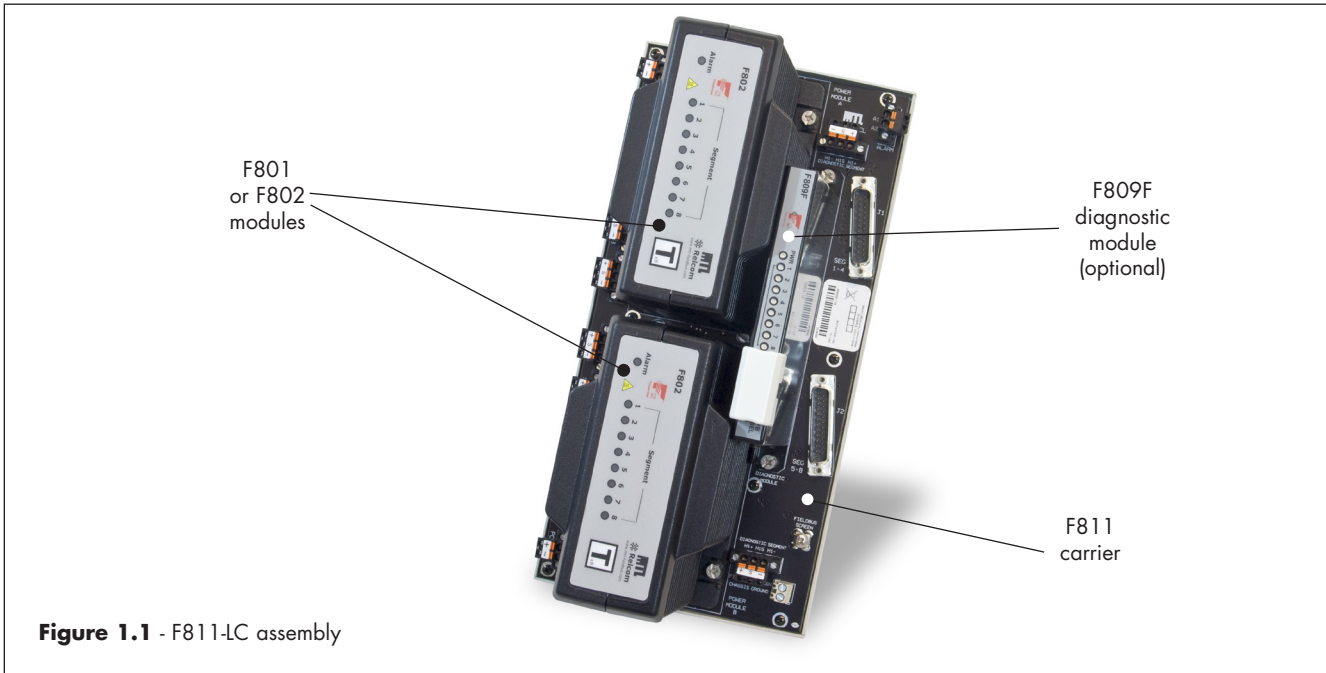

Figure 1.1 - F811-LC assembly

## 1 OVERVIEW

This manual explains the installation of the F811 fieldbus power system, which is designed to provide redundant FOUNDATION™ fieldbus power for Foxboro I/A Series® control systems using FBM228 modules. Eight fieldbus segments are supported.

The F811 module carrier has system connectors for direct connection to two simplex or redundant pairs of FBM228 modules mounted on standard Foxboro baseplates using the standard cables. For extreme reliability, the module carrier has no components and only provides interconnections between Foxboro standard system cables; the F801 or F802 power modules; the F809F diagnostics module and the external connections.

In general purpose, safe area applications, the system is fully 'hot-swappable' - meaning that individual power modules and input power supplies can be replaced without interrupting power or communication on the fieldbus segment, assuming that redundant F80x power modules are fitted.

The system is designed so that power for several fieldbus segments can be provided from a single assembly with minimal wiring.

## 2 COMPONENTS AND ACCESSORIES

The F811 system comprises the following components.

Description	Part No.
Left-hand carrier, unpopulated	F811-CL-P*
Right-hand carrier, unpopulated	F811-CR-P*
8-segment power module: 21.5V, 350mA	F801
8-segment power module: 28V, 500mA	F802
Blanking module	F800-BLK
Fieldbus diagnostic module	F809F
F811-CL-P* and two F80x modules	<u>with F801</u> F811-L*
F811-CR-P* and two F80x modules	<u>with F802</u> F811-R*
F811-CL-P* and one F80x module	F811-L*-NR
F811-CR-P* and one F80x module	F811-R*-NR

\* = S or C      S = Pluggable Screw Terminal Connectors  
C = Pluggable Spring Clamp Connectors

## 3 DESCRIPTION

The system comprises a module carrier which accommodates two MTL F801 or F802 power modules operating in redundant configuration. Failure alarms, galvanic isolation, power conditioning and segment termination are incorporated into each power module.

Each F80x module has indicator LEDs to show both its status and that of the eight segments under power. In normal operation, each green 'Segment' LED is lit, showing that the segment is powered. If a segment is shorted, or its voltage is below the rated output, this LED is extinguished, and the red 'Alarm' LED is lit. In the alarm condition, a normally closed, galvanically-isolated relay contact goes to an open condition. Connections to the alarm relay are made via screw terminals on the F811 carrier. If multiple F811 units are used, a common alarm circuit can be achieved by 'daisy-chaining' the alarm circuits.

Any F80x module provides galvanic isolation between the 24V DC input power and the fieldbus segments, as required by the IEC61158-2 fieldbus standard and the Foundation™ FF-831 validation test for power conditioners. There is also galvanic isolation between the fieldbus segments, thereby preventing multiple segment failures from ground faults on more than one segment. Each segment has its own fieldbus power conditioner and current limitation. Termination of the fieldbus segment is automatically maintained when single or redundant F80x modules are fitted.

An optional F809F diagnostic module may be installed on the carrier to collect and distribute diagnostic information automatically on each of the eight fieldbus segments. Measured parameters may be viewed in the Foxboro control system by either assigning the F809F as a fieldbus device to segment one or eight, or on a separate segment. Connections for a separate segment are provided on the carrier. For more information, see the F809F product specification.

Redundant 24V DC (nom.) input power can be connected to the F811 carrier via the power connection terminals.

Field wiring connections are available with either pluggable screw terminals or pluggable spring clamp terminals depending upon the model number specified - see Section 2 on this page.

I/A Series® is a registered trademark of Invensys plc, London, England

**F811-CL**

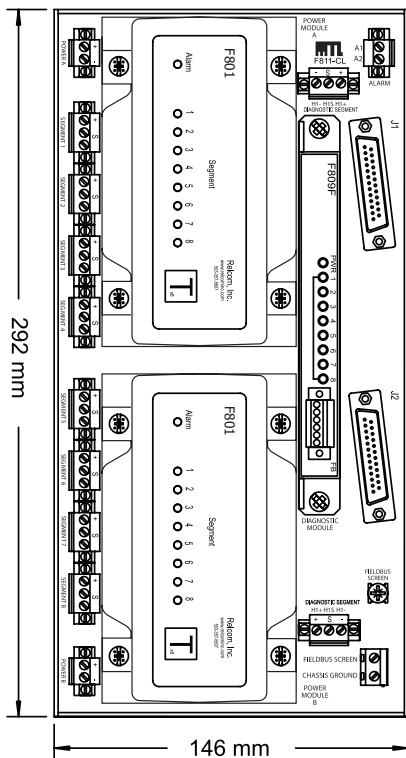

**F811-CR**

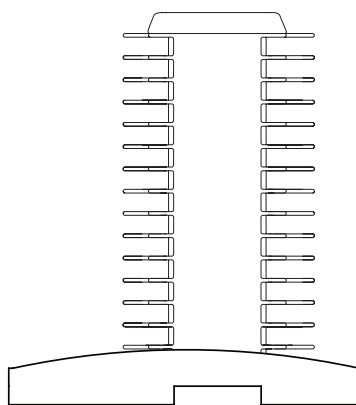
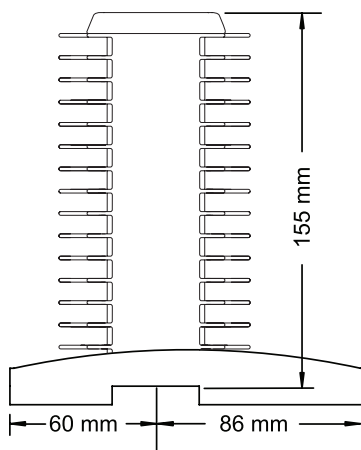
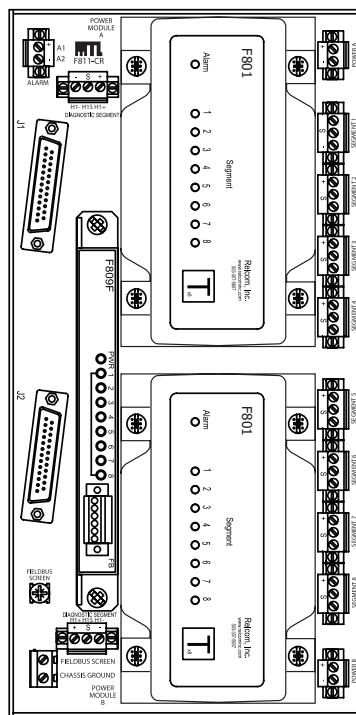

**Figure 4.1** - F811 carrier models showing modules and dimensions

## 4 MECHANICAL INSTALLATION

The layout of the F811 carriers, including details of the overall dimensions and DIN-rail fixings, is shown in Figure 4.1.

### 4.1 General

These power systems may be mounted only in safe areas and wherever they are located, the mounting conditions must:

- prevent any form of pollution that could compromise the operation of the unit. For example, an unpolluted location or a suitable enclosure could be chosen.
- provide an adequate level of mechanical protection. This can be achieved by selecting a protected location, a suitable cabinet or enclosure, or a combination of both.
- ensure that all cable entries and connections are secure by making provision for the careful routing and securing of all cables.

- provide adequate security against unauthorised interference.
- ensure that the permitted ambient operating temperature range of the units ( $-40^{\circ}\text{C}$  to  $+65^{\circ}\text{C}$ ) is not exceeded. *If F802 Power Modules are to be used at 60% or more of their full-load rating then they must be de-rated to 50°C.* Power dissipation within the cabinet or enclosure and the effect of heating from sunlight exposure should be considered.
- be aware that the weight of a carrier and two power modules will be in the range of 3.8 - 4.0kg; and more if the diagnostic module is fitted.

### 4.2 Mounting orientation

It is recommended that an F811 carrier is mounted on a vertical surface with the orientation of the F80x modules as shown in Figure 4.1 above. Any other orientation will not provide optimum airflow for the F80x power modules. The carrier is provided with two channels that have clamping tabs for DIN-rail mounting.

#### 4.2.1 Outdoor mounting

If the assembly is to be mounted in an outdoor location, use a suitable enclosure with a minimum of IP54 ingress protection. A higher degree of ingress protection is recommended if the atmosphere can become corrosive, wet or dusty.

### 4.3 Carrier mounting

The carrier is designed for mounting on 35mm x 7.5mm T-section "top hat" DIN rail to EN 50022 and uses six built-in DIN clamp tabs to hold it on the rail. The Power Modules (F801 or F802) must be removed from the carrier to obtain access to the DIN-rail clamp screws.

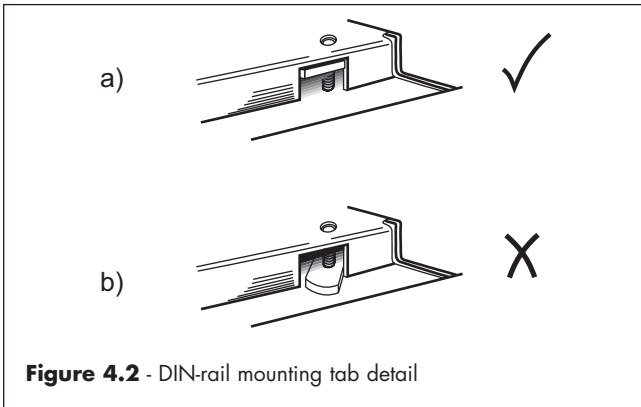

Figure 4.2 - DIN-rail mounting tab detail

#### 4.3.1 Mounting procedure

Before starting to mount the carrier on the DIN rail, rotate each of the clamp screws counterclockwise (i.e. unscrew) until the clamping tabs reach the position shown in Figure 4.2a and none of the tabs extend into the channel for the DIN rail.

Press the carrier onto the DIN rail and rotate each of the clamp screws clockwise until the tab tightens against the rail. The clamping tabs can be seen through the "Inspect clamps" holes in the carrier when they are in the correct position.

#### 4.3.2 Removal from DIN rail

To obtain access to the DIN-rail clamp screws the Power Modules must be removed from the carrier. Support the carrier by pressing it to the DIN rail and unscrew (counterclockwise) the six DIN-rail clamp screws. Turn each screw approximately two full turns to release its clamping tab from the rail. Remove the carrier.

### 4.4 Mounting and removal of Modules

Each power module has four captive screws to secure it to the carrier. Align the module over its electrical connectors on the carrier, press it to the carrier and hold it in place while tightening the four fixing screws.

To remove a power module, support the module while unscrewing the four fixing screws at its base then lift the module off its carrier connector.

The F809F diagnostic module is secured to the carrier with two screw mountings. Use a similar technique to that given above to fit and remove this module.

## 5 ELECTRICAL INSTALLATION

### 5.1 Introduction

#### 5.1.1 Supplying the Power Modules

The input power for the F80x power modules can be supplied from one external bulk supply.

See Figure 5.1 for additional details.

#### 5.1.2 Redundancy

For redundant operation, F80x modules are fitted in Power Module A and Power Module B locations.

For non-redundant operation fit the F80x in the Power Module A location, i.e. the top position as shown in Figure 4.1.

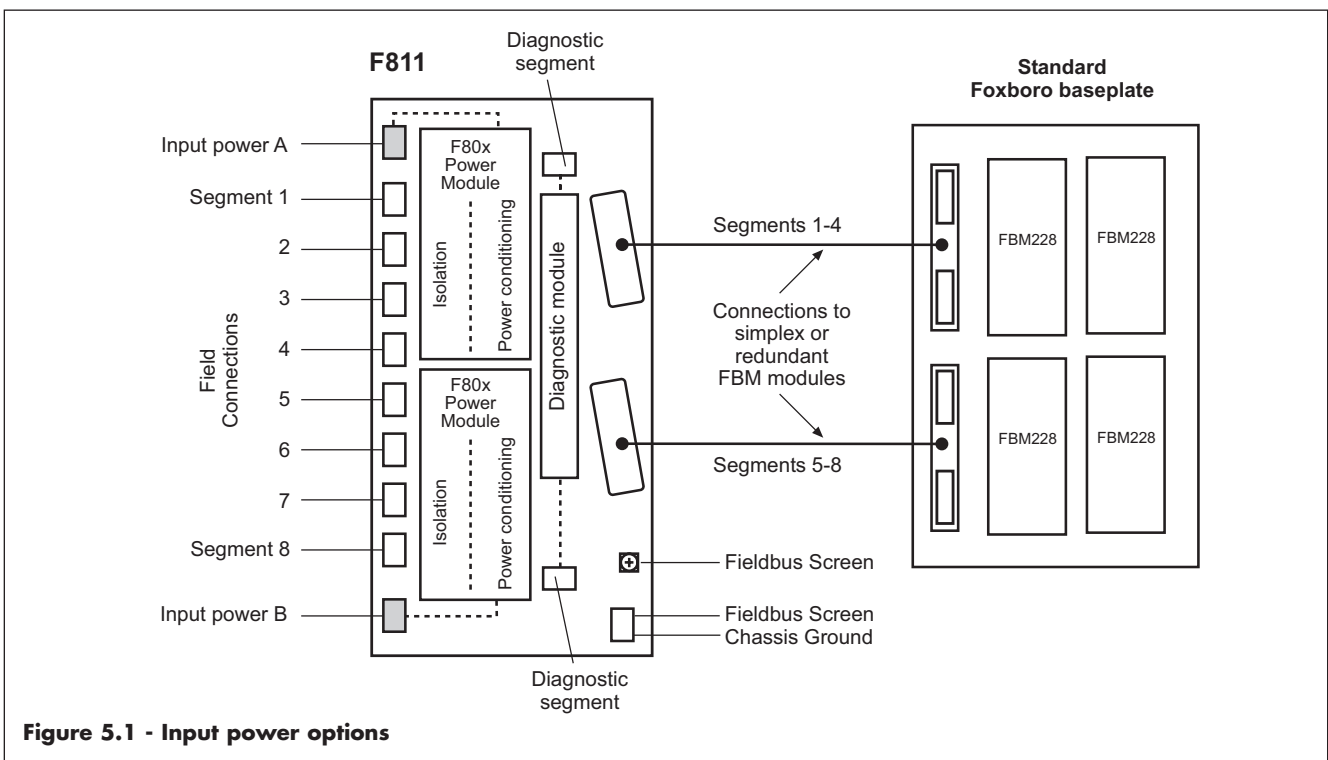

Figure 5.1 - Input power options

## 5.2 Input power connections

The F80x modules are powered separately from external bulk power supplies via board-mounted terminals. The upper terminal block (Power A) supplies Power Module A and the lower terminal block (Power B) supplies Power Module B - see Figure 5.1. Connect separate external 19.2 - 30.0V DC supplies to the '+' and '-' terminals of these connectors - observing the correct polarities.

The cable length to these bulk supply inputs must be limited to a maximum of 30 metres.

### 5.2.1 Over-current protection

A fully populated F811 carrier with two F801 power modules and an F809F diagnostic module fitted draws a maximum current of 3.5A at 24V DC, whereas with two F802 power modules and a F809F diagnostic module fitted, it draws a maximum current of 6.0A at 24V DC.

Suitably rated fuses or circuit breakers must be installed in the primary and secondary 24V DC power supply connections. For example, a rating of 10A is suitable for protection of a single F811 carrier. This rating is required in the primary and secondary sources of supply, to ensure continued operation in the event of a failure of one supply. If a single method of over-current protection is provided for multiple carriers, the power supply wiring must be capable of sustaining the short-circuit current.

## 5.3 Alarm circuit

Each F80x power module contains an alarm relay and the contacts of the relay are normally held closed while the module is in its normal "no alarm" condition.

A shorted segment, the "failure" of any of the incoming bulk power supply, or an F80x module failure, will cause the relay contacts in the F80x module to open, signalling an alarm condition.

### 5.3.1 Alarm terminals

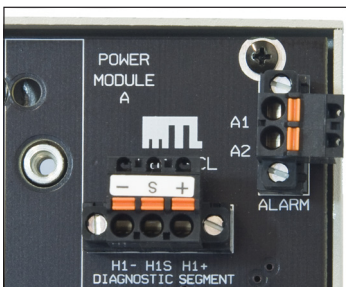

Figure 5.2 - Alarm relay connector

A pair of terminals is provided on the carrier near the J1 host connection (see Figure 5.2) to make connection to the alarm relay's switch contacts.

These terminals 'A1' & 'A2' are the ends of a series connection of the alarm circuits of both power modules (see Figure 5.3).

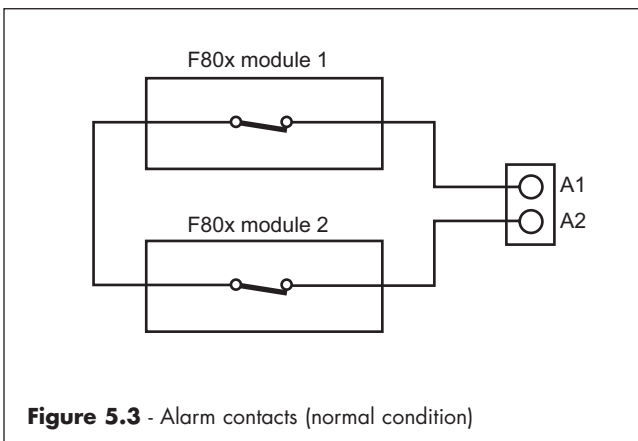

Figure 5.3 - Alarm contacts (normal condition)

The alarm contacts may be daisy-chained with the alarm contacts on other F811 carriers.

### 5.3.2 Simplex operation

If one of the F80x modules is not fitted; for example in a non-redundant application, or for repair or replacement; a "simplex adapter" (part number F800-BLK - see Figure 5.4) can be fitted to the empty F80x connector position to provide continuity for the alarm circuit (see Section 5.3.1); this prevents an alarm being signalled when one F80x module is absent.

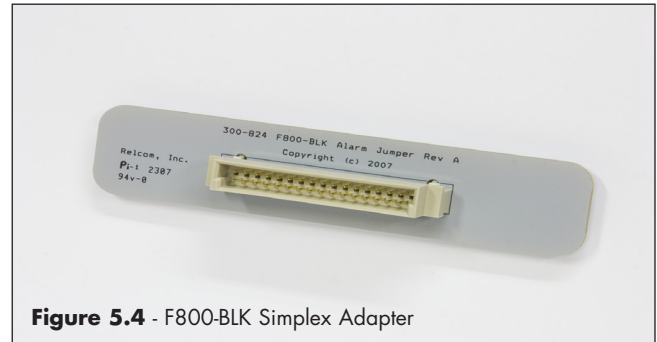

Figure 5.4 - F800-BLK Simplex Adapter

## 5.4 Connections to I/A baseplate

Two system connectors are provided for use with standard I/A system cable for connection to the I/A baseplate for mounting simplex or redundant FBM228 fieldbus I/O modules.

## 5.5 Fieldbus segment connections

The eight fieldbus segments connections are located on the side of the carrier beside the F80x power modules - as shown in Figure 5.1. The connectors are pluggable and available in a rising cage clamp screw version (-PS) or a spring clamp version (-PC). See Figure 5.5.

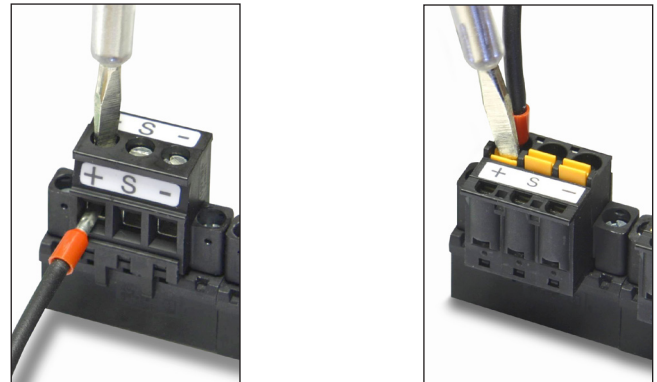

Figure 5.5 - Screw terminal and spring-clamp connectors

The terminals can accept the following conductor sizes:

Type	Conductor size
Screw terminals (-PS)	0.14 to 2.5mm <sup>2</sup>
Spring clamp terminals (-PC)	0.2 to 2.5mm <sup>2</sup> flexible or rigid

**Note:** When wiring to spring-clamp terminals, use a screwdriver with a 3 - 4 mm blade and depress the spring-clamp button before inserting the termination cable. See Figure 5.5.

If the fieldbus cable screens are to be grounded at the F811 then they should be connected to the 'S' terminal on each connector. However, if they are not grounded at the F811, the screen wire should be cut off and insulated to avoid contact with the board.

### 5.5.1 Terminator

A *single terminator* is provided automatically on each segment whether one or two F80x Power Modules are used.



## 5.6 Grounding

### 5.6.1 Fieldbus ground

The 'S' terminals of the fieldbus segment connectors are all connected on the carrier to an M4 screw terminal, and also to a cage-clamp screw terminal both labelled "Fieldbus Screen" (see Figure 5.6). Either of these should be connected to a "clean" instrumentation ground.

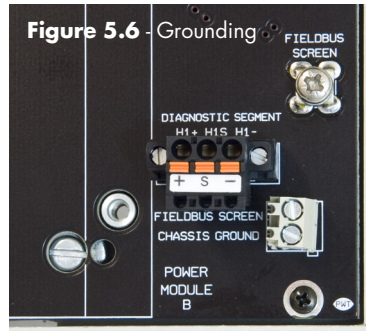

### 5.6.2 Chassis ground

A protective and EMC ground connection ("Chassis Ground") is available at the same terminal block terminal as the Fieldbus Screen connection point (see Figure 5.1). Chassis Ground is connected internally to the metal cases of the F80x power modules and the F809F diagnostic module and should be connected to the cabinet ground.

## 5.7 Diagnostics module

A Fieldbus Diagnostic Module, type F809F, can be fitted on the F811 carrier. It may be assigned as a participant fieldbus device on segments 1 or 8 or, alternatively, it can communicate with the Foxboro I/A control system by means of a dedicated FOUNDATION™ fieldbus H1 segment. Refer to the separate instruction manual for the F809F (INM F809F) for further details.

Figure 5.7 shows how a dedicated diagnostic segment, comprising multiple F811 carriers, is interlinked, powered and terminated. Where carriers are installed in vertical columns, connect the H1+, H1- and H1S terminals of adjacent carriers as shown. A segment may support a number of F809F modules. The actual number is based on a number of factors:

- the logical device limit of the host,
- the fieldbus power supply capacity,
- operational constraints such as bandwidth and
- the overall (system) impact of the loss of that diagnostic segment

It is recommended that shielded, twisted-pair cable, complying with FOUNDATION fieldbus™ 'Type A' construction shall be used.

### 5.7.1 Diagnostics module power supply

The diagnostic segment must be powered by a conditioned fieldbus power supply (see Figure 5.7), such that a voltage in the range 9–32V DC is available at each F809F fieldbus diagnostic module connected on the segment.

**Note:** This power is not provided automatically from the F811 carrier and must be connected as shown in Figure 5.7

This power supply may be either simplex or redundant, depending on the application, and be capable of providing sufficient current for the entire diagnostic segment. Each F809F module draws approximately 15mA, so a segment comprising 10 modules will, for example, require an output current of at least 150mA. A suitable redundant fieldbus power supply is MTL-Relcom type FPS-I, which provides 350mA at 25.0V DC. Alternatively, type FPS-DT provides two segments of non-redundant power.

### 5.7.2 Diagnostics module segment termination

The diagnostic segment must be terminated at both ends to maintain the bus impedance within FOUNDATION fieldbus™ limits. A terminator must therefore be connected between the H1+ and H1- terminals of the diagnostic bus connector at the far end of the segment (see Figure 5.5). A suitable terminator for this purpose is MTL type FBT1-IS.

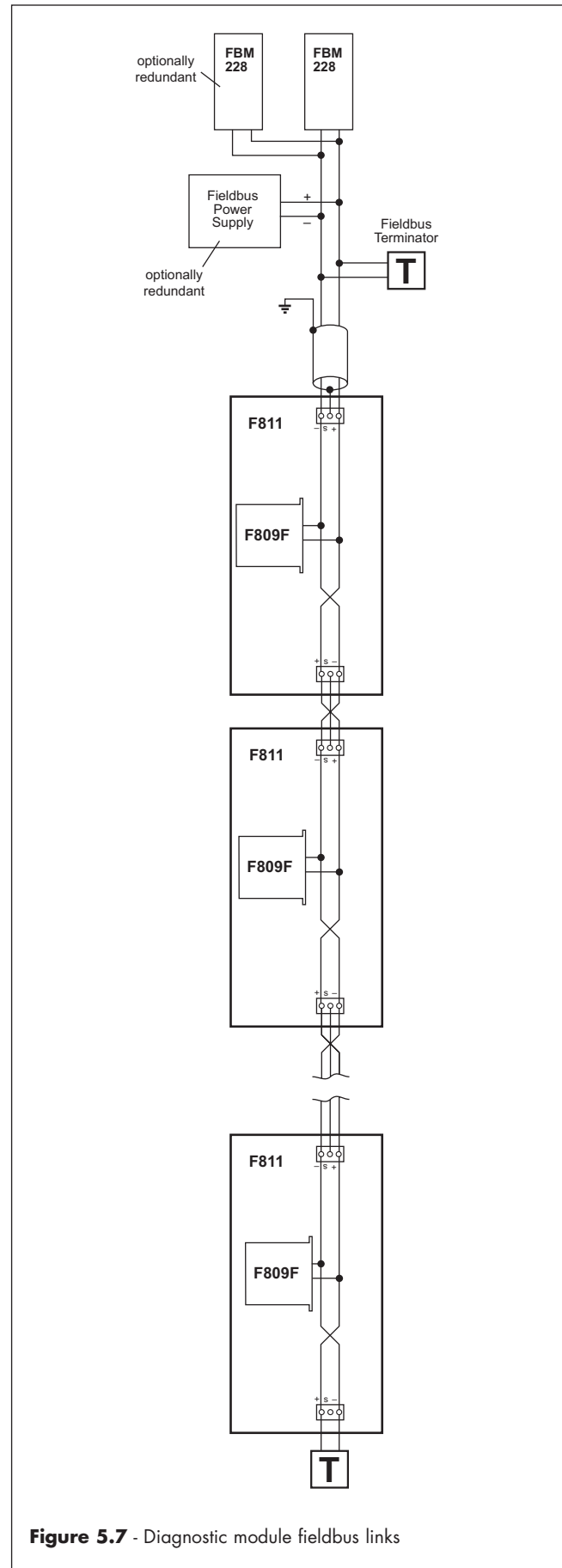

Figure 5.7 - Diagnostic module fieldbus links

Termination of the bus at the opposite end may be provided by an integrated terminator within the power supply (such as exists within the FPS-I and FPS-DT types) or by means of a separate terminator.

## 6 TESTING & TROUBLESHOOTING

The F811 circuit board has no discrete components fitted so testing is confined to the operation of the modules fitted to the backplate.

### 6.1 F80x Status and Alarm LEDs

Each F80x power module is fitted with nine LEDs, eight to indicate segment status and one to signify an Alarm condition. Use Figure 6.1 below to help identify error conditions. Note: The LEDs on the F802 power modules will operate in the same manner.

### 6.2 Testing after installation

Apply power and, by consulting Figure 6.1, ensure that the **Normal** condition applies to the power modules.

If redundant power supplies are being used, disconnect the incoming secondary power and check that Fault condition c) occurs. Replace the secondary power connector and remove the primary and the module LED displays should be the reverse of condition c), i.e. module A LED display will now look like module B's and B's will look like A.

If external bulk supplies are being used - as described in Section 5.2.2 - it might be useful to perform a similar procedure where Power A and Power B connectors are removed in turn and the module LED displays should perform in the same manner as that just described.

## 6.3 Troubleshooting

The power module LED displays shown in Figure 6.1 should be consulted for help in identifying problems occurring with power supply or segment faults.

## 7 MAINTENANCE

### 7.1 Routine maintenance

Check the general condition of the installation occasionally to make sure that no deterioration has occurred. At least every two years (and more frequently for particularly harsh environments) check:

- ◆ the condition of wire connection/terminations/screens.
- ◆ the dc output voltage on each of the four fieldbus segments is >21.5V for the F801 and >28V for the F802. This can be performed using a multimeter or a Relcom FBT-3/ FBT-6 fieldbus tester.
- ◆ that the segment LEDs on the F80x module(s) are functioning and the Alarm LED(s) is not lit.
- ◆ that the retaining screws are tight.
- ◆ that there are no signs of damage or corrosion.

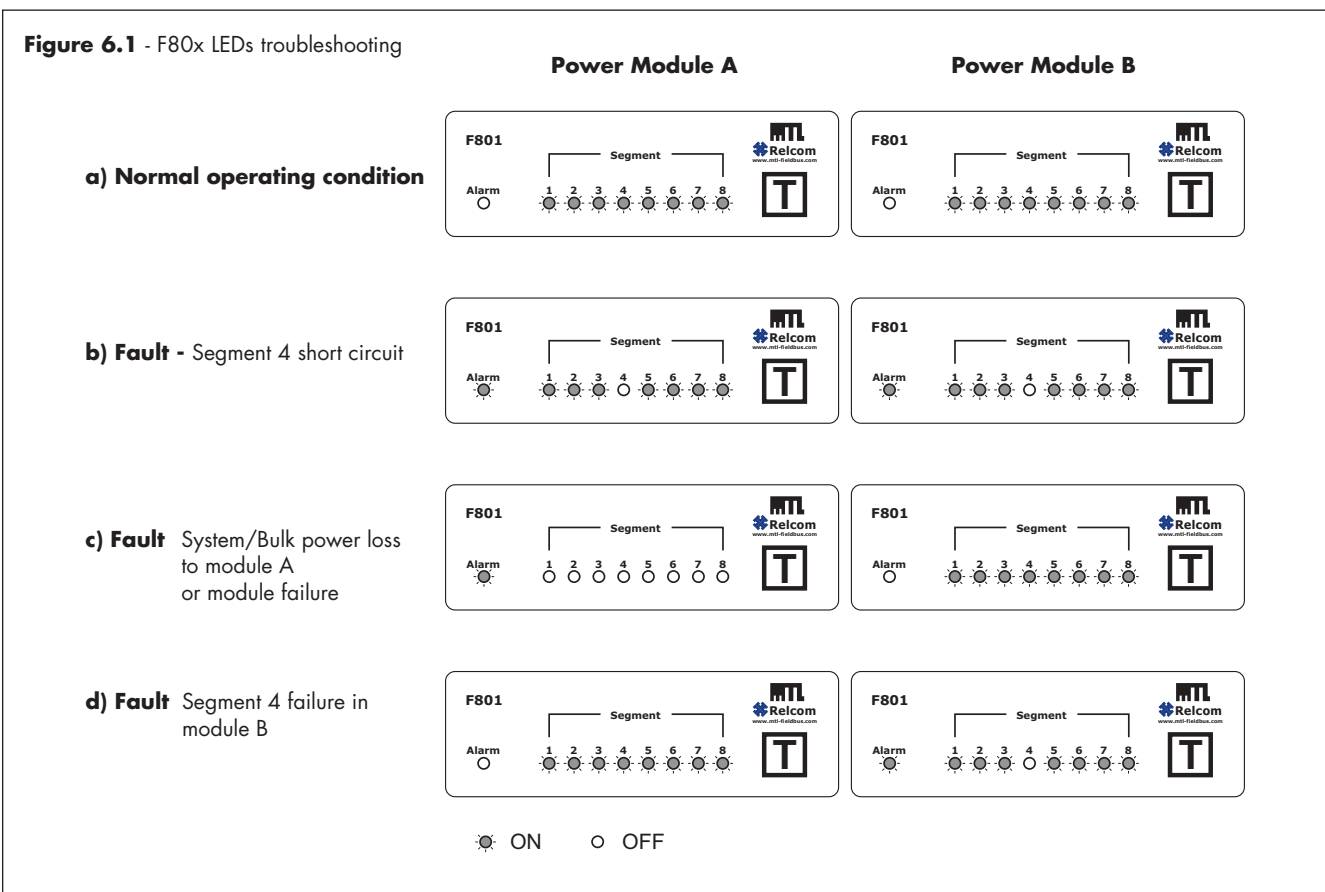

**This page left intentionally blank**

**MTL Instruments Pty Limited**

9 /12 Billabong Street  
Stafford  
Queensland 4053  
Australia  
Tel: + 61 1300 308 374 Fax: + 61 1300 308 463  
E-mail: enquiries@mtlaus.com.au

**Cooper Electric (Shanghai) Co. Ltd.**

Room 2001, China Life Tower  
16 Chao Yang Men Wai Street  
Chao Yang District, Beijing  
China 100020  
Tel: + 86 10 5980 0288 Fax: + 86 10 8562 5725  
E-mail: bjsales@mtl-inst.cn

**MTL Instruments sarl**

Les Carrés du Parc  
10 rue des Rosiéristes  
69410 Champagne au Mont d'Or  
France  
Tel: +33 (0)4 78 64 98 32 Fax: +33 (0)4 78 35 79 41  
E-mail: info@mtl-inst.fr

**MTL Instruments GmbH**

An der Gumpgesbrücke 17  
D-41564 Kaarst  
Germany  
Tel: +49 (0)2131 718930 Fax: +49 (0)2131 7189333  
E-mail: info@mtl.de

**MTL India**

No. 36, Nehru Street  
Off Old Mahabalipuram Road  
Sholinganallur  
Chennai - 600 119  
India  
Tel: + 91 (0)44 24501660/24501857 Fax: + 91 (0)44 24501463  
E-mail: sales@mtlindia.com

**MTL Italia srl**

Via Cantù 11  
I - 20092 Cinisello Balsamo MI  
Italy  
Tel: +39 (0)2 61802011 Fax: +39 (0)2 61294560  
E-mail: info@mtl-inst.it

**Cooper Crouse-Hinds Japan KK**

MT Building 3F  
2-7-5 Shiba Daimon  
Minato-ku Tokyo  
Japan 105-0012  
Tel: +81 (0)3 6430 3128 Fax: +81 (0)3 6430 3129  
E-mail: sales@mtlkk.co.jp

**Cooper Crouse-Hinds Korea**

12F, Vision Tower  
707-2 Yeoksam-dong, Gangnam-gu  
Seoul 135-080  
South Korea  
Tel: +82 2 3484 6795 Fax: +82 2 3484 6778

**MTL Instruments BV**

MTL Instruments BV  
Terheijdenseweg 465  
4825BK Breda  
The Netherlands  
Tel: +31 (0)76 7505360 Fax: +31 (0)76 7505370  
E-mail: info@mtlbenelux.com

**Cooper Crouse-Hinds Pte Ltd.**

No.2 Serangoon North Avenue 5  
#06-01 Fu Yu Building  
Singapore 554911  
Tel: +65 6 487 7887 Fax: +65 6 487 7997  
E-mail: sales@mtlsing.com.sg

**MTL Instruments**

Villa No. 4, Sector 2-17, Street 6  
PO Box 53234,  
Abu Dhabi, UAE  
Tel: +971 2 446 6840 Fax: +971 2 446 6841  
E-mail: mtlgulf@mtl-inst.com

**Measurement Technology Limited**

Great Marlings, Butterfield, Luton, Beds  
England LU2 8DL  
Tel: +44 (0)1582 723633 Fax: +44 (0)1582 422283  
E-mail: enquiry@mtl-inst.com

**Cooper Crouse-Hinds MTL Inc**

3413 N. Sam Houston Parkway W.  
Suite 210  
Houston TX 77086  
USA  
Tel: +1 281 571 8065 Fax: +1 281 571 8069  
E-mail: csinfo@mtl-inst.com

