

STT 3000 Smart Temperature Transmitter

Model STT350

EN01-5222
September 2010

Specification and Model Selection Guide

Introduction

Honeywell's microprocessor based STT350 Smart Temperature Transmitter converts a primary sensor input into an output signal for a conventional 4 to 20mA, two wire loop.

This universal temperature input model readily accepts signals from a wide variety of industry standard thermocouples or resistance temperature detectors (RTDs) as well as a straight millivolt or Ohms sensor. Its output signal is either proportional to the measured variable or linearized to temperature, and is transmitted in either an analog 4-20mA format or a digital DE protocol format for direct digital integration to the TPS® control system. You easily select the analog or digital format for the output signal transmission through the Smart Field Communicator® (SFC) which is the common hand-held operator interface for our Smartline™ Transmitters. All configuration, operation and communication functions are under the control of the STT350's microprocessors and are implemented through the SFC.



Figure 1 – STT350 Transmitter in Field Mount Housing.

Features

- Single model accepts input signals from a choice of primary sensors to satisfy varying applications requirements with minimum transmitter inventory.
- Standard digital cold-junction compensation function provides accurate and reliable temperature measurement over a wide ambient operating range.
- Direct digital integration with TPS system provides local measurement accuracy to the system level without adding typical A/D and D/A converter inaccuracies.
- Added Smart features include reading of the highest and lowest inputs, external cold junction compensation temperature at an isothermal block and engineering units displayed in degrees C, F, K, or R plus millivolt and Ohms.
- Suitable for DIN rail mounting or remote field mounting in a flameproof housing.
- Smart transmitter personality with local or remote interfacing means significant manpower efficiency improvements in commissioning, start-up, and ongoing maintenance functions.
- Automatically provides true differential temperature measurement of thermocouple or RTD inputs by individual linearization of each sensor reading and then computing the difference.
- Suitable for true 4-wire Pt100 measurement (or 3- or 2-wire).
- FISCO approved
- Write protect link included to safeguard configuration settings.
- Designed to be in compliance with EMC requirements and is CE-Marked.
- Includes sensor break detection on all input wires.
- Post read validation of the measured signal before providing fresh output.
- Supports dual thermocouple sensor inputs for redundant sensor operation.
- Integral analog or digital indicating meter option
- Surge/lightning protection options can be installed internally in housing or externally in conduit.

Description

The STT350 transmitter is suitable as a direct replacement for any conventional temperature transmitter in use today. Its memory contains the characteristics of most commonly used temperature sensors. This means that you can use the SFC to configure the transmitter for any of these sensors and it will automatically correct for their associated non-linearities. You make all transmitter adjustments and diagnostic checks through an SFC connected anywhere across the 4-20mA wire route. This lets you initiate configuration and maintenance functions at locations remote from the transmitter itself. The SFC is also fully compatible with all other Honeywell Smartline Transmitters. The transmitter module can also be installed on a standard DIN rail (to EN50022) or remotely mounted in a flameproof housing designed for either surface or two-inch pipe-stand mounting. Transmitters can be pre-configured at the factory to your exact specifications or they will be shipped with factory default configuration—ready to accept your own configuration.

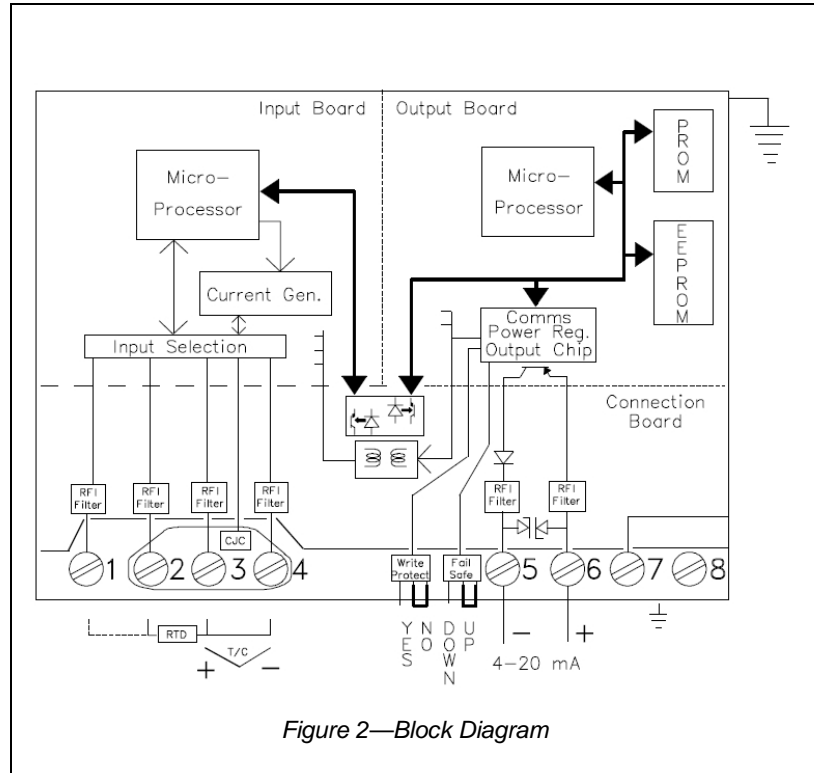

Performance Under Rated Conditions

Input Type	Digital Accuracy for Maximum Range Limits % of Max. Span	Maximum Range Limits		Digital Accuracy for Normal Range Limits		Normal Range Limits		Standards
		°C	°F	°C	°F	°C	°F	
RTD								
Pt 100	0,01	-200 to 850	-328 to 1562	0,1	0,18	-200 to 450	-328 to 842	IEC 751:1986 (a=0.00385)
Pt 200	0,01	-200 to 850	-328 to 1562	0,1	0,18	-200 to 450	-328 to 842	IEC 751:1986 (a=0.00385)
Pt 500	0,02	-200 to 850	-328 to 1562	0,1	0,18	-200 to 450	-328 to 842	IEC 751:1986 (a=0.00385)
Pt 100J	0,01	-200 to 640	-328 to 1184	0,1	0,18	-200 to 450	-328 to 842	JISC 1604-81 (a=0.00392)
Ni 50	0,04	-80 to 150	-112 to 302	0,1	0,18	-50 to 150	-58 to 302	Honeywell Type A
Cu 10	0,37	-20 to 250	-4 to 482	1,0	1,8	-20 to 250	-4 to 482	General Electric
Cu 25	0,19	-20 to 250	-4 to 482	0,5	0,9	-20 to 250	-4 to 482	General Electric
T/C:								
B	0,14	200 to 1820	392 to 3308	1,0	1,8	550 to 1820	1022 to 3308	IEC 584-1 (ITS-90)
C	0,03	0 to 2300	32 to 4172	0,6	1,08	0 to 1650	32 to 3002	IPTS 68
D	0,03	0 to 2300	32 to 4172	0,6	1,08	330 to 1370	626 to 2498	IPTS 68
E	0,04	-200 to 1000	-328 to 1832	0,2	0,36	0 to 1000	32 to 1832	IEC 584-1 (ITS-90)
J	0,04	-200 to 1200	-328 to 2192	0,2	0,36	0 – 800	32 to 1472	IEC 584-1 (ITS-90)
K	0,04	-200 to 1370	-328 to 2498	0,3	0,54	-120 to 1370	-191 to 2498	IEC 584-1 (ITS-90)
N	0,06	-200 to 1300	-328 to 2372	0,3	0,54	0 to 1300	32 to 2372	IEC 584-1 (ITS-90)
R	0,09	-50 to 1760	-58 to 3200	0,5	0,9	500 to 1760	932 to 3200	IEC 584-1 (ITS-90)
S	0,08	-50 to 1760	-58 to 3200	0,5	0,9	500 to 1760	932 to 3200	IEC 584-1 (ITS-90)
T	0,14	-250 to 400	-418 to 752	0,2	0,36	-100 to 400	-148 to 752	IEC 584-1 (ITS-90)
NiNiMoly	0,03	0 to 1300	32 to 2372	0,3	0,54	780 to 1300	1436 to 2372	G.E. (IPTS – 68)
Radiomatic	0,6	420 to 1800	788 to 3272	0,7	1,26	780 to 1800	1436 to 2372	Honeywell (RH)
Millivolts	0,01	-20 to 120 mV		8µV		-10 to 45 mV		
Ohms	0,01	0 to 2000 Ω		0,15Ω		0 to 2000 Ω		

Note that the Page 2 Accuracy values are available merely by selecting the sensor type and range (i.e. without user calibration). Improvements of up to 2 times can be obtained for the accuracy by calibrating to the required LRV/URV values. All STT350 units pass through 20 hours of Environmental Stress Screening (ESS) by fast cycling between -40 and +85°C to ensure maximum product reliability. During this ESS process, the ambient temperature compensation coefficients are determined for individual units and burned in transmitter memory to provide maximum performance over a wide range of operating conditions.

SPECIFICATIONS

Operating Conditions				
Parameter	Reference conditions	Rated Condition	Operative Limits	Transportation and Storage
Ambient Temperature	23°C ± 2 73°F ± 4	-40 to 85 -40 to 185	-40 to 85 * -40 to 185	-50 to 100 -58 to 212
Humidity				
Rack Mounting %RH	10 to 55	5 to 95	5 to 100	5 to 100
Mounted in EP %RH	10 to 55	5 to 100	5 to 100	5 to 100
Housing				
Supply Voltage, Current and Load Resistance	Voltage Range : 10.8 to 42.4 Vdc at the transmitter terminals Current Range : 3.6 to 21.8 mA Load Resistance : 0 to 1450 Ohms (as shown in Fig 3)			
Vibration	Maximum of 4g over 15 to 200Hz. (restricted to 3g with indication meter)			
Shock	Maximum of 40g			
Output D/A Accuracy		±0.025% of span		
Cold Junction Accuracy		± 0.25°C		
Total Reference Accuracy In Analog Mode=		Digital Accuracy of input + Output D/A Accuracy + CJ Accuracy (T/Cs only)		
In Digital Mode =		Digital Accuracy of input + CJ Accuracy (T/Cs only)		
		(example: transmitter operating in Analog Mode with Pt100 sensor and 0 to 200°C Total Reference Accuracy = 0.1 + ((200/100) x 0.025) = 0.15°C		
Digital Ambient Temperature Effect (per 10°C change from 20°C reference)		RTDs or Ohms : 0.029% of reading T/Cs or mV : 0.042% of reading		
Cold Junction Rejection Effect		60:1 for changes from 23°C ambient		
Output D/A Ambient Temperature Effect		0.045% of span per 10°C change		
Total Output Ambient Temperature Effect (ATE) In Analog Mode =		Digital ATE + Output D/A ATE + CJ ATE (T/Cs only)		
In Digital Mode =		Digital ATE + CJ ATE (T/Cs only)		
Power Supply Voltage Effect		0.005% of span per Volt		
Parameter	Description			
Adjustment Range	No limits to adjustments within the Maximum range except minimum span limit of 1 engineering unit e.g. 1°C			
Output (2 Wire)	4-20mA or Honeywell DE digital protocol Extended range: 3.8-20.8mA. Fail safe modes <3.8mA or 21.8mA			
Damping Time Constant	Adjustable from 0 to 102 seconds digital damping			
Thermocouple Burnout	Burnout detection is user selectable Upscale or downscale with critical status message			
Input to Output Galvanic Isolation	Meets dielectric strength test of 1400Vac rms (50/60Hz) 2000Vdc for 1 minute			
Series Mode Rejection	40dB (100 to 1) for 50 or 60Hz ±0.5Hz (with internal software filter set to local power line frequency)			
EMC Compliance	In compliance with 89/336/EEC, Electromagnetic Compatibility (EMC) Directive			
RFI Rejection	±0.1% of span at 30V/m over 20 to 1,000MHz in explosion-proof housing with shielded cables			
Update Rate	2 to 5 measurements per second depending on input variation			
Response Time	1.5 seconds to 90% of final step value			
Stability/Time Drift	0.05% of maximum span per year. Auto calibration against internal reference every second.			

Short term Operative Limit of -50°C (-58°F)

Physical Mounting, Construction and Approvals			
Parameter	Description		
Mounting	DIN rail (top hat or G rail) Field Mount Housing with surface mounting or 2-inch pipe mounting (IP 66/NEMA 4X Rating) Field Mount Housing meets the applicable requirements of NEMA 7 and 9		
Wiring	Screw Terminals - M3.5x6.7mm nickel coated brass Accepts up to 12AWG, 16AWG recommended		
Net Weight	Transmitter for DIN rail mount - 0.5kg (1.1 pounds) Transmitter in EP or XC housing - 1.6kg (3.6 pounds) Transmitter + indicator in housing - 2.4kg (5.2 pounds)		
Materials of construction	Transmitter module - Aluminum housing with baked on Polyester paint cover - Noryl terminal block. EP housing - Aluminum housing with baked on epoxy-polyester hybrid paint cover (beige) XC housing - Aluminum housing with baked on 2 coats epoxy resin cover (beige) ST02 housing - Aluminum housing with baked on 2 coats epoxy resin cover (red)		
Dimensions	See Fig 4		
Sensor/Cable Entry (EP, XC or ST02 Housing)	1/2 inch NPT electrical connection with optional adapters for M20x1.5, or 3/4 inch NPT		
Safety Approvals	STT350 Module	CENELEC	Intrinsically Safe Ex ia IIC T4/T5/T6 with 30V/100mA/1.2W barrier (T4/T5/T6 = -20 to +80/+50/+40 °C ambient)
		CSA	Intrinsically Safe Class I, Div. 1, Groups A to D
		FM	Intrinsically Safe Class I, II, III, Div. 1, Groups A to G Non-incendive Class I, Div. 2, Groups A to D Suitable for Class II, III, Div. 2, Groups F and G
			Russian Certificate of pattern Approval No 332 of 18/10/94 IEC 68 and IEC 801
	Additional Approvals with EP, XC or ST02 Housings	<u>With or Without Integral Meter</u> Zone 2: T6, 28V/22mA Cenelec Flame Proof Ex d IIC T6 CSA Explosion Proof Class I, II, III, Div. 1, Groups B to G FM Explosion Proof Class I, II, III, Div. 1, Groups B to G <u>Without Integral Meter</u> FM Explosion Proof Class I, II, III, Div. 1, Groups A to G	
Surge/Lightning	Internal SP Selection	10 kA peak current (8/ 20 µs waveform), 10kV peak Voltage (10/50 µs waveform)	
Protection Options	External LP Selection	10 kA peak current (10/ 20 µs waveform), 500A peak Current (10/1000 µs waveform)	
Thermowell & Probe Availability	STT350 can be supplied integrally mounted with any of the previously listed standard resistance temperature devices (RTDs) and thermocouple (T/Cs) elements. Probe Types: <ul style="list-style-type: none"> • 1/4" Rigid or spring loaded RTDs or T/Cs in Inconel or Stainless Steel sheaths in standard lengths from 3" to 24" (other lengths by request). • Standard or heavy duty service. • Locally mounted to the STT350 housing or remotely mounted into explosion-proof mounting heads. • With (or without) probe lag hardware : Hex nipple, Straight nipple or Double lag and Union connections. • Single or dual element availability; grounded or ungrounded T/Cs Additionally, the following types of Thermowells can also be provided as an integral thermal solution : Thermowell Materials: Carbon Steel, 304SS, 316SS, 316L SS, 446SS, Hastelloy B, Hastelloy C, Monel, Inconel 600 (other materials by request). Thermowell Types: Threaded well, Flanged well, or Socket well, (with or without thermowell lag extensions). Flange Types: Raised Face, Flat Faced and Ring Type Joint flange availability in 1", 1.5", 2" or 3" sizes. Flange Ratings: ANSI 150#, 300#, 600# and 1500# ratings.		

NOTE: A minimum of 250 Ohms of loop resistance is required to support communications. Loop resistance is the total of loop wiring resistance, safety barrier and receiving device input developing resistor.

The triangle outlined by the heavy lines alongside shows the operating area for field wiring and barrier resistance beyond the 250 Ohms necessary for communications.

If a Smart Meter is included in the loop, allow an additional 2.25 Volts for meter power.

If surge lightning protection is included this adds 44 Ohms to the loop resistance; i.e., allow 1 Volt additional supply or reduced loop wiring power.

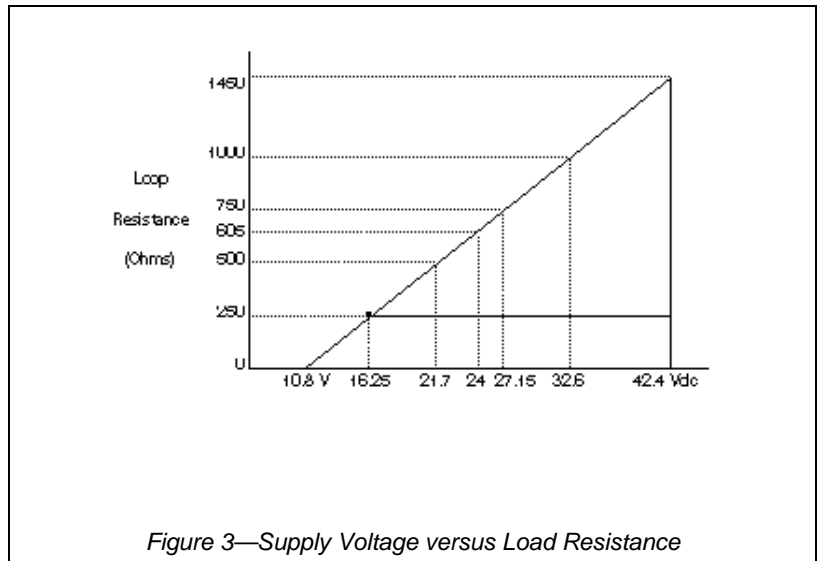

Figure 3—Supply Voltage versus Load Resistance

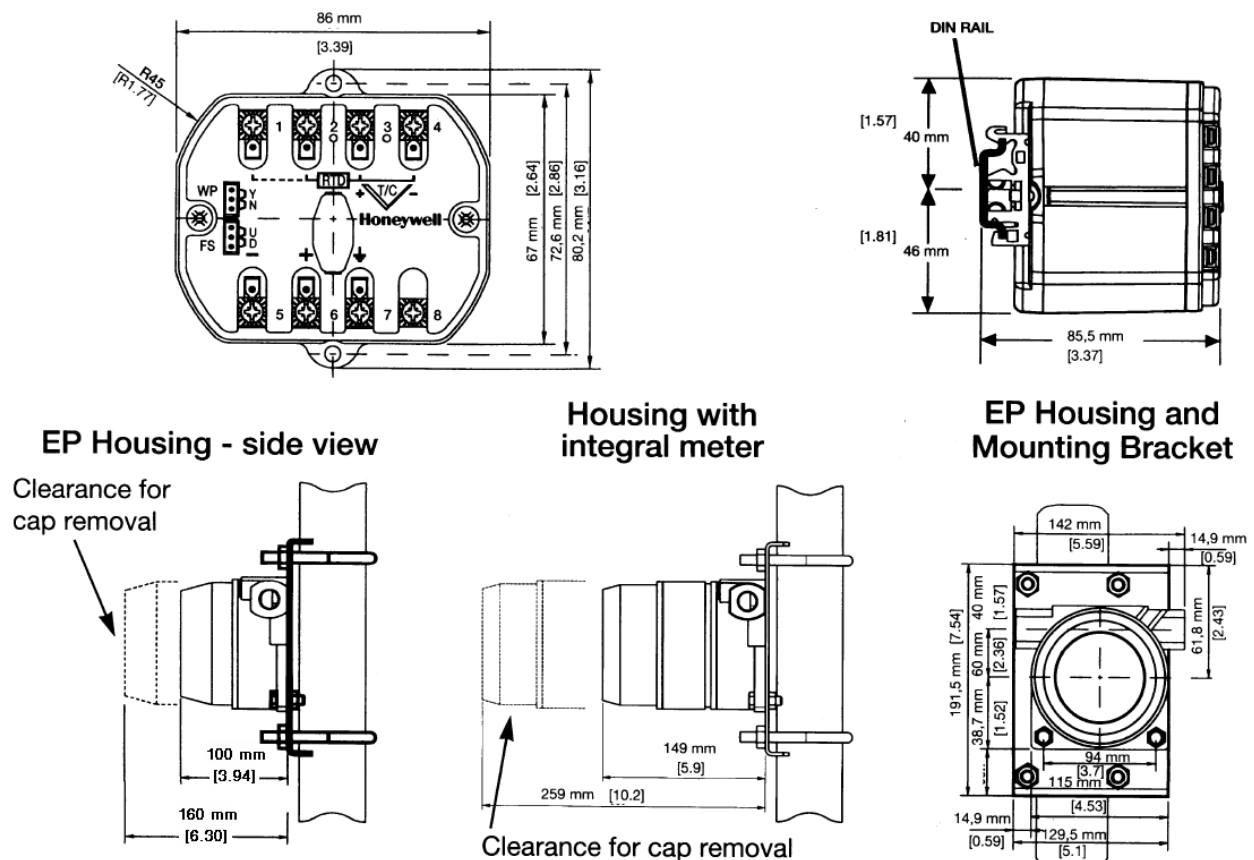

Figure 4—STT350 Transmitter and Optional Flameproof Housing Dimensions –reference only – mm (inches)

Model Selection Guide (34-44-16-02)

Model Selection Guides are subject to change and are inserted into the specifications as guidance only. Prior to specifying or ordering a model check for the latest revision Model Selection Guides which are published at: <http://hpsweb.honeywell.com/Cultures/en-US/Products/Instrumentation/ProductModelSelectionGuides/default.htm>



34-44-16U-02
Issue 33
Page 1 of 4

**STT 3000 Temperature Transmitter
Models STT350 & STT35F Fieldbus**

Model Selection Guide



Instructions

- Select the desired Key Number. The arrow to the right marks the selection available.
 - Make one selection from each table using the column below the proper arrow.
 - A dot (•) denotes unrestricted availability. A letter denotes restricted availability.
 - Restrictions follow Table VII.
- Key Number I II III IV V VI VII
- STT35_ - [] - [] - [] - [] - [] - [] - []

KEY NUMBER

Description	Selection	Availability
STT350 Smart Temperature Transmitter Module (4-20mA/DE) *	STT350	↓
STT35F Fieldbus Temperature Transmitter Module *	STT35F	↓
All modules carry the following approvals: (See Approvals Table VII for more information)		
CE Mark: All modules carry CE Mark and are in compliance with EN 50081-2 and 50082-2.		
Russian Certificate of Pattern Approval No. 2064 of Jan. 1988.		

* Use of STT350/35F within Class II or III, Division 1 or 2, Groups E, F and G requires the use of explosion-proof field mount housing option.

TABLE I - Sensor Probe and Thermowell Accessories

No Integral Sensor Probe or Thermowell Supplied	0	•	•
---	---	---	---

TABLE II - Transmitter Housing and Integral Meters (Select approval body certification in Table VII)

Explosion-Proof Field Mount Housing (Note 2)	No Housing Supplied	00 __	•	•
	Aluminum with beige epoxy coating	EP __	•	•
	For Stainless Steel or Red Epoxy Painted Housing, select Table II EP __ and appropriate Table VI code.			
Integral Meter (Note 3)	No Meter Supplied	__ 00	•	•
	Analog Meter for Field Mount Housing	__ ME	j	
	Digital Meter for Field Mount Housing	__ SM	j	
	Fieldbus Digital Meter for Field Mount Housing	__ FM		j

TABLE III - Configuration & Tagging

Configuration	None - Factory Default Configuration Supplied	00 __	•	•
	Transmitter Configuration (see 13:STT-OE-5 for choices)	TC __	•	
	Transmitter Configuration - (Fieldbus)	FC __		•
Customer Tagging (Note 4)	No Tagging Requested	__ 00	•	•
	316 SS Wired-on Customer I.D. Tag - (4 lines, 28 characters per line, customer specified information)	__ TG	j	j
	316 SS Wired-on Customer I.D. Tag (blank)	__ TB	j	j

Note 1: Specify 8 digit customer I.D. when probe/well selected. See Price Pages 13:TP-1 to 16 for sensor/well pricing.

Note 2: With a housing, 20 characters max. of customer information is available on the nameplate at no charge. (See 13:STT-OE-5 for ordering instructions.)

Note 3: Remote Meter available as Model RMA300 (See Price Page 13:RM-1.)

Note 4: Replaces Selection ____US

34-44-16U-02
Issue 33
Page 2 of 4

Availability
STT35_ ↓ ↓
 0 F

TABLE IV - Optional Equipment

		Selection	0	F
Mounting Arrangement	No Mounting Arrangement Supplied	00 _____	•	•
	DIN Rail Mounting via 2 Clips (to Top Hat or "G" Rail)	DR _____	k	k
	Carbon Steel Mounting Bracket for 2" Pipe	MB _____	j	j
	Stainless Steel Mounting Bracket for 2" Pipe	SB _____	j	j
316 SS Conduit Adaptor for Wiring Entry	No Adaptor(s) Supplied - 1/2" NPT Conduit Connection	___ 0 ___	•	•
	1/2" NPT to M20 x 1.5 1 Adaptor	___ 1 ___	•	•
	(EEx d IIC Approved) 2 Adaptors	___ 2 ___	•	•
	1/2" NPT to 3/4" NPT 1 Adaptor	___ 3 ___	•	•
Lightning Protection	No Lightning Protection Supplied	___ 00 ___	•	•
	External Lightning Protection - Mountable to Housing	___ LP ___	j	j
	Internal Surge/Lightning Protection	___ SP ___	j	j
Operator/User Manual	None	___ 00 ___	•	•
	English Version (for STT35F Only)	___ EF ___		•
	English Version (for STT350 Only) ⁽⁴⁾	___ EN ___	•	
	French Version	___ FR ___	•	
	Spanish Version	___ SP ___	•	

TABLE V - Optional Extended Warranty Coverage & Certificates

Optional Extended Warranty	Standard Warranty	0 __	•	•
	Additional Warranty - 1 year	1 __	•	•
	Additional Warranty - 2 years	2 __	•	•
	Additional Warranty - 3 years	3 __	•	•
	Lifetime Warranty - 15 years	L __	•	•
Optional Certificate (Note 5)	No Transmitter Configuration/ Calibration Certificate	_ 0 _	•	•
	Transmitter Configuration/ Calibration Certificate (D-0097-RD.A)	_ D _	•	•
	No Certificate of Conformance/ Origin	_ _ 0	•	•
	Certificate of Conformance/ Origin (D-0098-RD.A)	_ _ C	•	•

TABLE VI - Additional Features

No Selection	0000	•	•
Red Epoxy Painted Housing Cap	ST01	j	j
Red Epoxy Painted Explosion-Proof Housing (Note 6)	ST02	g	g
316 Stainless Steel Explosion-Proof Housing (Note 6)	ST07	g	g

Pricing Table A

Table VI	Table II
ST07	EP00
	EPME
	EPSM
	EPFM

Note 5: Installation Guide, chosen Operator's Manuals and chosen Certificates are automatically shipped with unit.
See 13:STT-OE-7 for additional manuals and alternate shipping.

Note 6: Must be ordered with Table II EP __.







STT35 - Availability

TABLE VII - Safety Approval Body Selection Appearing on Housing Nameplate e

Approval Body	Approval Type	Location or Classification	Selection	0	F
None	No approval body certifications included		00	•	•
FM Approvals	Explosion-proof Dust-Ignition-proof	Class I, Div. 1, Groups A,B,C,D Class II, III Div. 1, Groups E,F,G	1C	f	f
	Intrinsically Safe Nonincendive Suitable for Outdoor Location	Class I, II, III, Div. 1, Groups A,B,C,D,E,F,G Class I, Div. 2, Groups A,B,C,D Class II, III, Div. 2, Groups F, G Enclosure Type 4X			
	Explosion-proof Dust-Ignition-proof	Class I, Div. 1, Groups B,C,D (with Indicatio Class II, III, Div. 1 Groups E,F,G			
	Intrinsically Safe Nonincendive Suitable for Outdoor Location	Class I, II, III, Div. 1, Groups A,B,C,D,E,F,G Class I, Div. 2, Groups A,B,C,D Class II, III, Div. 2, Groups F, G Enclosure Type 4X			
	Intrinsically Safe Nonincendive	Class I, II, III, Div. 1, Groups A,B,C,D,E,F,G Class I, Div. 2, Groups A,B,C,D			
	Explosion-Proof Dust Ignition-Proof	Class I, Div. 1, Groups B,C,D Class II, III, Div. 1, Groups E,F,G			
CSA	Intrinsically Safe Suitable for Outdoor Location	Class I, II, III, Div. 1, Groups A,B,C,D,E,F,G Class II, III, Div. 2, Groups F, G Enclosure Type 4X	2J	j	j
	Intrinsically Safe Suitable for	Class I, II, III, Div. 1, Groups A,B,C,D,E,F,G Class I, Div. 2, Groups A,B,C,D	2G	m	m
ATEX*	Intrinsically Safe, Zone 0/1	 II 1 G EEx ia IIC T4, T5, T6 (Module)	3S	•	•
	Flameproof, Zone 1	 II 2 G EEx d IIC T5, T6 Enclosure rated IP 66/67	3D	j	j
	Non-Sparking, Zone 2	 II 3 G EEx nA, T5, T6, Zone 2 (Honeywell) Module to be installed in enclosure rated IP 54 minimum	3N	•	•
	Multiple Marking**, Int. Safe, Zone 0/1, or Flameproof, Zone 1, or Non-Sparking, Zone 2	 II 1 G EEx ia IIC T4, T5, T6  II 2 G EEx d IIC T5, T6  II 3 G EEx nA, IIC T5, T6 (Honeywell) Enclosure IP 54 minimum	3H	j	j
SA	Intrinsically Safe, Zone 0/1	Ex ia IIC T4 (Ta = 70°C)	4S	•	
INMETRO (Brazil)	Flameproof	BR-Ex d IIC T6, (Ta -50 to 80°C), T5, (Ta - 50 to 85°C)	6D	j	j
	Intrinsically Safe	BR-Ex ia IIC T6, (Ta -50 to 40°C), T5, (Ta - 50 to 55°C), T5, (Ta -50 to 85°C) BR-Ex ia IIC T6, (Ta -50 to 40°C), T5, (Ta - 50 to 50°C), T5, (Ta -50 to 85°C)	6S	•	•
IECEX	Intrinsically Safe, Zone 0/1	Ex ia IIB or IIC T6 (Ta = -50°C to +40°C) Ex ia IIB or IIC T5 (Ta = -50°C to +50°C) Ex ia IIB or IIC T4 (Ta = -50°C to +85°C) (Module only, IP 20)	CS	•	•
	Flameproof, Zone 1, Intrinsically Safe, Zone 0/1	Ex d IIC T6 (Ta = -50°C to +80°C) Ex d IIC T5 (Ta = -50°C to +85°C) Ex ia IIB or IIC T6 (Ta = -50°C to +40°C) Ex ia IIB or IIC T5 (Ta = -50°C to +50°C) Ex ia IIB or IIC T4 (Ta = -50°C to +85°C) Enclosure IP 66/67	CA	j	j

* See ATEX installation requirements in Operator's Manuals EN11-6162 & EN11-6196

The user must determine the type of protection required for installation of the equipment. The user shall then check the box [✓] adjacent to the type of protection used on the equipment certification nameplate. Once a type of protection has been checked on the nameplate, the equipment shall not be reinstalled using any of the other certification types.

34-44-16U-02
Issue 33
Page 4 of 4

RESTRICTIONS

Restriction Letter	Available Only With		Not Available With	
	Table	Selection	Table	Selection
f	II	EP	II	SM, FM
g	II	EP		
j	II	EP		
k	II	0000		
m			II	EP

Notes: See 13:STT-9 and User's Manual for part numbers.
 See 13:STT-OE-5 for OMS Order Entry Information including tagging, transmitter configuration, manuals, certificates, drawings and SPINS.
 To request a quotation for a non-published "special", fax RFQ to Marketing Applications at 602 313-6155.

Ordering Example: STT350-0-EPME-0000-0000000-000-0000-0000

Warranty/Remedy

Honeywell warrants goods of its manufacture as being free of defective materials and faulty workmanship. Contact your local sales office for warranty information.

If warranted goods are returned to Honeywell during the period of coverage, Honeywell will repair or replace without charge those items it finds defective. The foregoing is Buyer's sole remedy and is **in lieu of all other warranties, expressed or implied, including those of merchantability and fitness for a particular purpose.**

Specifications may change without notice. The information we supply is believed to be accurate and reliable as of this printing. However, we assume no responsibility for its use.

While we provide application assistance personally, through our literature and the Honeywell web site, it is up to the customer to determine the suitability of the product in the application.

Honeywell Process Solutions

1860 West Rose Garden Lane
Phoenix, AZ 85027
Tel: 877.466.3993 or 602.313.6665

www.honeywell.com/ps/hfs

EN01-5222
September 2010
© 2006-2010 Honeywell International Inc.

The Honeywell logo, consisting of the word "Honeywell" in a bold, red, sans-serif font.